



特点

- 全封闭陶瓷，金属螺柱型结构
- 符合JB/T8949.2-1999标准
- 承受高浪涌电流能力
- 螺栓为阴极或阳极的正向或反向结构

典型应用

- 直流电机控制，直流电源控制
- 交流开关及温度控制，同步电机励磁

V <sub>RRM</sub>	型号
1600V	ZP500A半凸1600V

符号	参数	测试条件	结温 T <sub>J</sub> (°C)	参数值			单位
				最小	典型	最大	
I <sub>F(AV)</sub>	正向平均电流	180° 正弦半波,50Hz 单面散热, T <sub>C</sub> =150°C	150			500	A
I <sub>F(RMS)</sub>	正向电流有效值	直流@110°C情况温度	150			785	A
V <sub>RRM</sub>	反向重复峰值电压	V <sub>DRM</sub> &V <sub>RRM</sub> tp=10ms	150	1600			V
I <sub>R(RM)</sub>	反向重复峰值电流	V <sub>RM</sub> =V <sub>RRM</sub>	150			15	mA
I <sub>FSM</sub>	正向不重复浪涌电流	10ms 底宽, 正弦半波 V <sub>R</sub> =0.6V <sub>RRM</sub>	150			8.25	KA
I <sup>2</sup> t	浪涌电流平方时间积					68	10 <sup>3</sup> A <sup>2</sup> S
V <sub>TO</sub>	门槛电压	150				0.83	V
r <sub>T</sub>	斜率电阻					0.91	mΩ
V <sub>FM</sub>	通态峰值电压	I <sub>TM</sub> =1500A, F=9.0KN	150			1.33	V
I <sub>rm</sub>	反向恢复电流	I <sub>TM</sub> =1500A, tq=1000us Di/dt=-20A/us. V <sub>r</sub> =50V	150			70	A
t <sub>rr</sub>	反向恢复时间					4.0	us
Q <sub>rr</sub>	恢复电荷					140	uC
R <sub>th(j-h)</sub>	热阻抗(结至散热器)	180° 正弦波, 双面(单面)冷却				0.090	°C/W
F <sub>M</sub>	安装力			85		120	N
T <sub>stq</sub>	储存温度			-40		200	°C
W <sub>t</sub>	质量						g
Outline	外形						

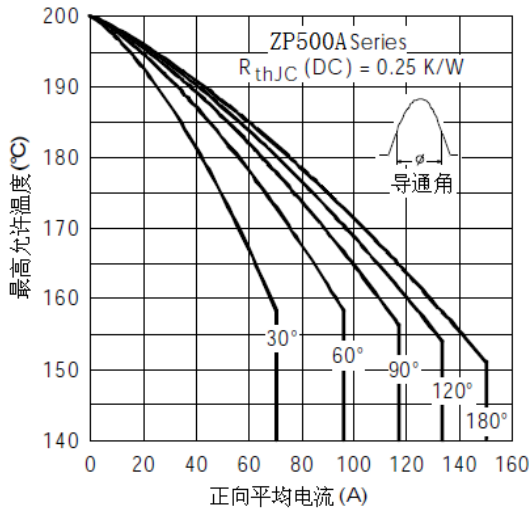

Fig. 1 - 额定电流特性

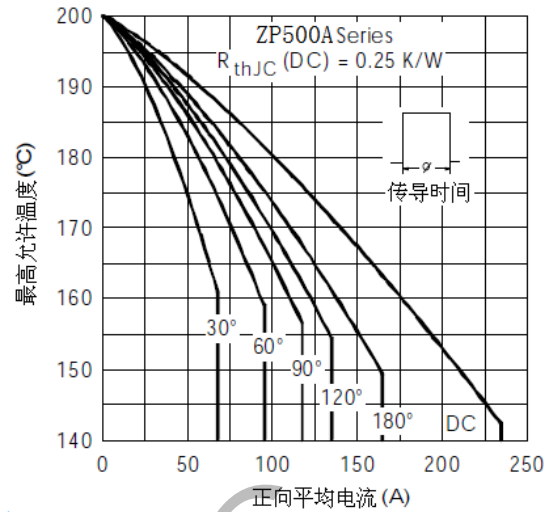

Fig. 2 - 额定电流特性

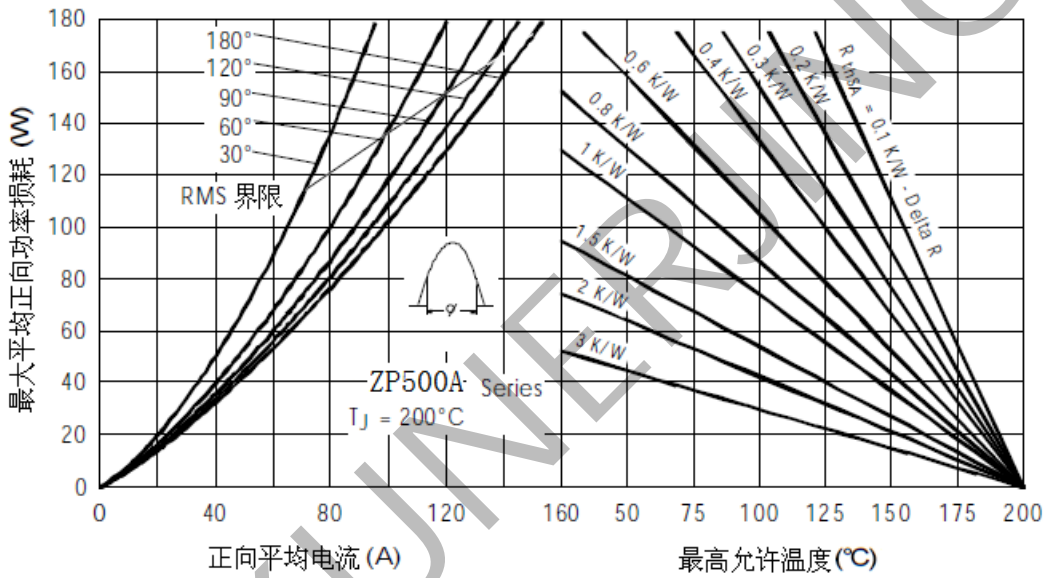

Fig. 3 - 正向功率损耗特性

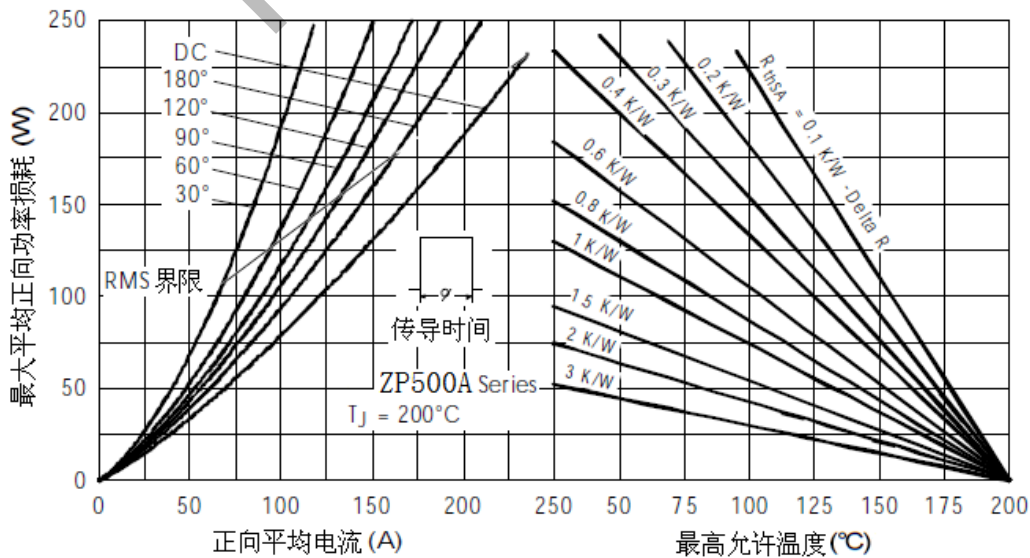

Fig. 4 - 正向功率损耗特性

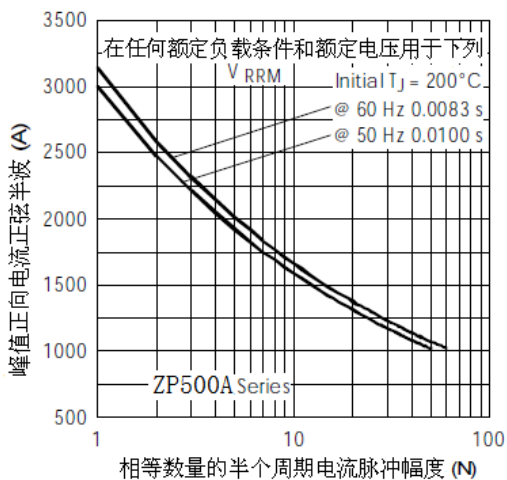

Fig. 5 - 最大反向浪涌电流

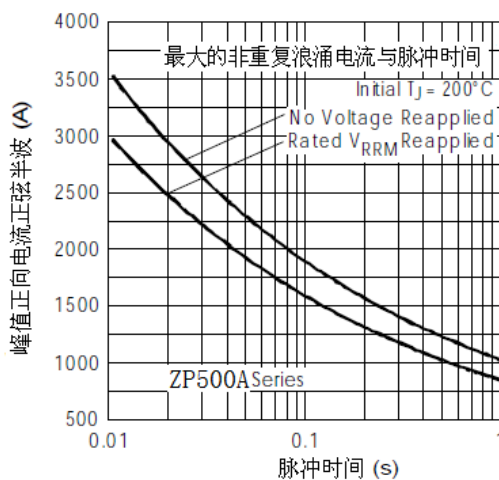

Fig. 6 - 最大反向浪涌电流

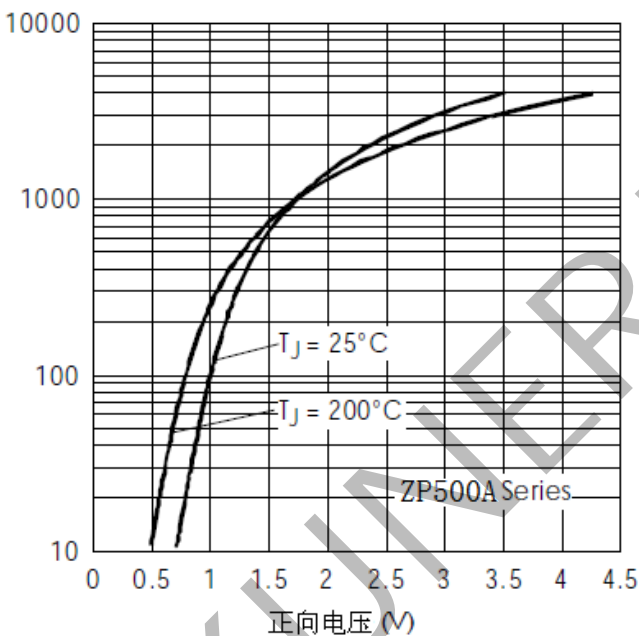

Fig. 7 - 正向压降特性

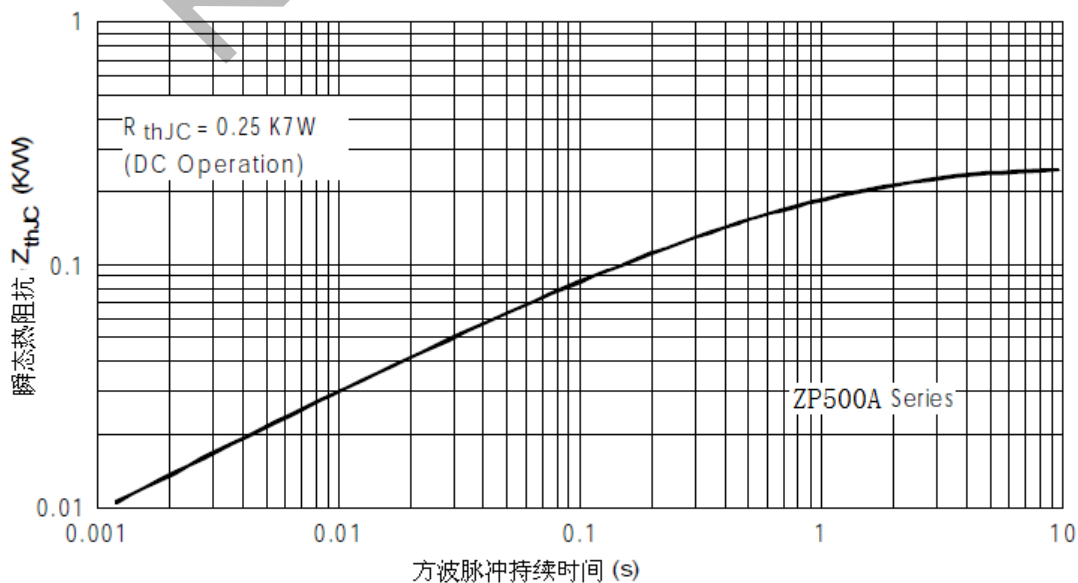
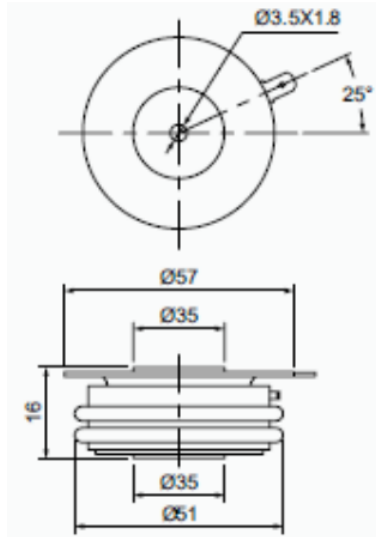

Fig. 8 -  $Z_{thJC}$  热阻抗特性



外形图:



KUNERJING