



特点

- 芯片与底板电气绝缘, 2500V交流电压
- 优良的温度特性和功率循环能力
- 350A以下模块皆为强迫风冷, 400A以上模块, 风冷, 水冷先用

典型应用

- 交直流电机控制, 各种整流电源
- 工业加热控制, 调光, 无触点开关
- 电机软起动, 无功补偿
- 电焊机, 变频器, UPS电源, 电池充放电

V _{DRM} , V _{RRM}	型号
1600V	MTC25A1600V-H20

符号	参数	测试条件	结温 T _J (°C)	参数值			单位
				最小	典型	最大	
I _{T(AV)}	通态平均电流	180° 正弦半波, 50Hz 单面散热, T _C =85°C	125			25	A
I _{T(RMS)}	方均根电流		125			41	A
V _{DRM} V _{RRM}	断态重复峰值电压 反向重复峰值电压	V _{DRM} &V _{RRM} tp=10ms	125	1600			V
I _{DRM} I _{RRM}	断态重复峰值电流 反向重复峰值电流	V _{DM} =V _{DRM} V _{RM} =V _{RRM}	125			8	mA
I _{TSM}	通态不重复浪涌电流	10ms 底宽, 正弦半波	125			0.55	KA
I ² t	浪涌电流平方时间积	V _R =0.6V _{RRM}					1.50
V _{TO}	门槛电压		125			0.85	V
r _T	斜率电阻						9.4
V _{TM}	通态峰值电压	I _{TM} =80A	25			1.60	V
dv/dt	断态电压临界上升率	V _{DM} =0.67V _{DRM}	125			1000	V/us
di/dt	通态电流临界上升率	I _{MT} =52A 门极触发电流幅值 I _{GR} =1.5A 门极电流上升时间 t _r ≤0.5us	125			150	A/us
I _{GT}	门极触发电流	V _A =12V, I _A =1A	25	20		100	mA
V _{GT}	门极触发电压			0.6		1.6	V
I _H	维持电流			15		150	mA
V _{GD}	门极不触发电压	V _{DM} =0.67V _{DRM}	125	0.2			V
R _{th(j-c)}	热阻抗 (结至壳)	180° 正弦波, 单面散热				0.950	°C/W
R _{th(c-h)}	热阻抗 (壳至散)	180° 正弦波, 单面散热				0.2	°C/W
V _{iso}	绝缘电压			2500			V
F _M	安装扭矩 (M5)			2.5		4.0	N-m
	安装扭矩 (M6)			4.5		6.0	N-m
T _{stq}	储存温度			-40		125	°C
W _t	质量						g
Outline	外形						

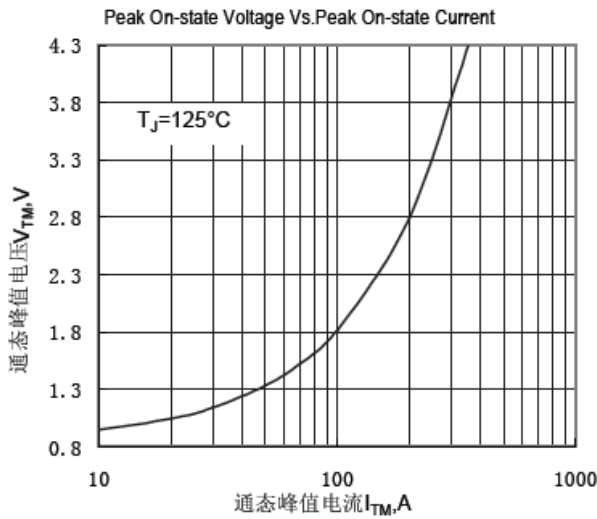

Fig.1 通态伏安特性曲线

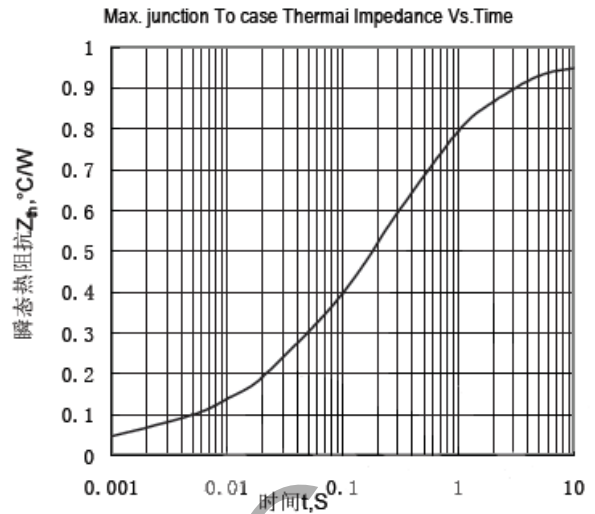

Fig.2 结至管壳瞬态热阻抗曲线

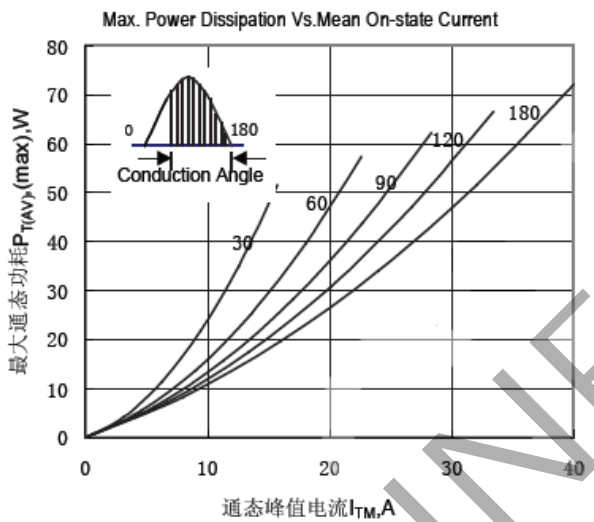

Fig.3 最大功耗与平均电流关系曲线

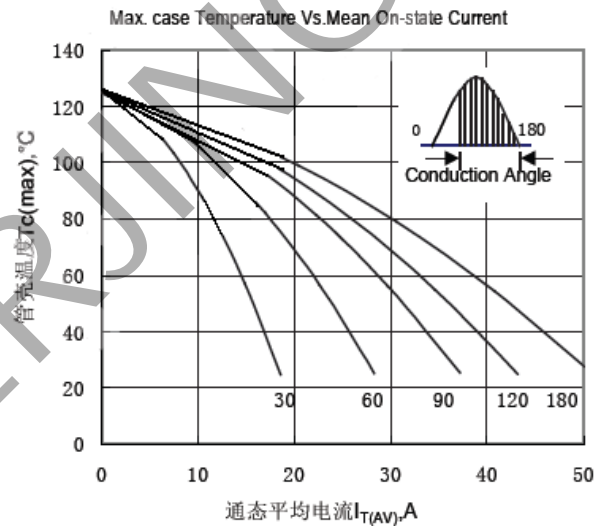

Fig.4 管壳温度与通态平均电流关系曲线

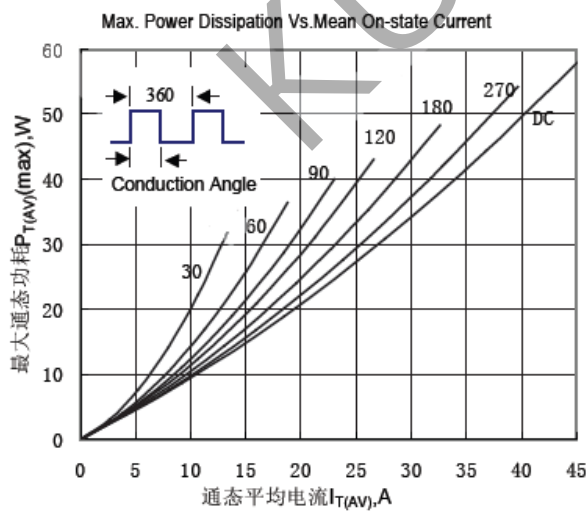

Fig.5 最大功耗与平均电流关系曲线

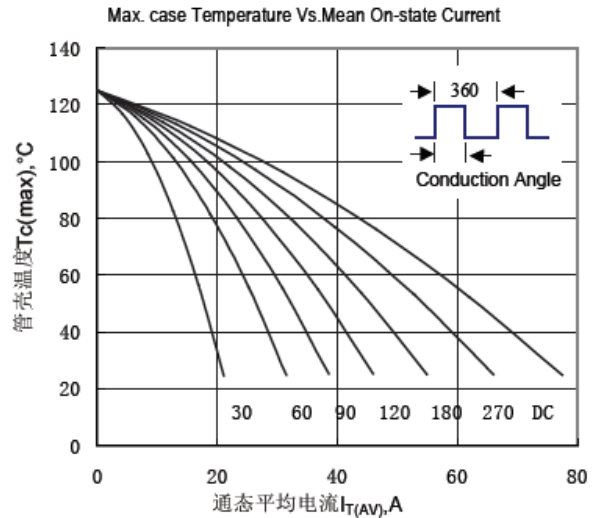

Fig.6 管壳温度与通态平均电流关系曲线

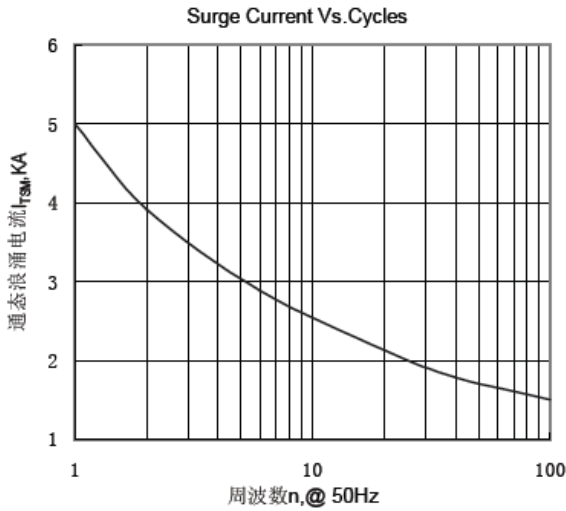

Fig.7 通态浪涌电流与周波数的关系曲线

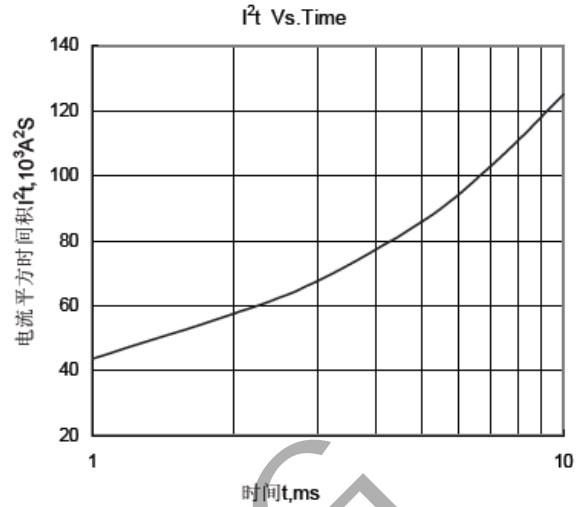

Fig.8 I²t 特性曲线

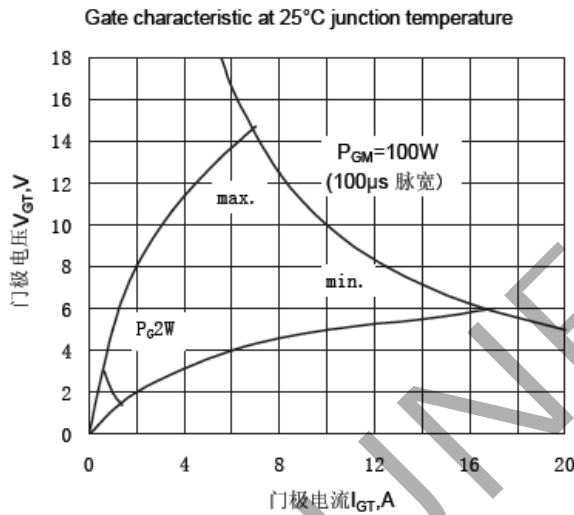

Fig.9 门极功率曲线

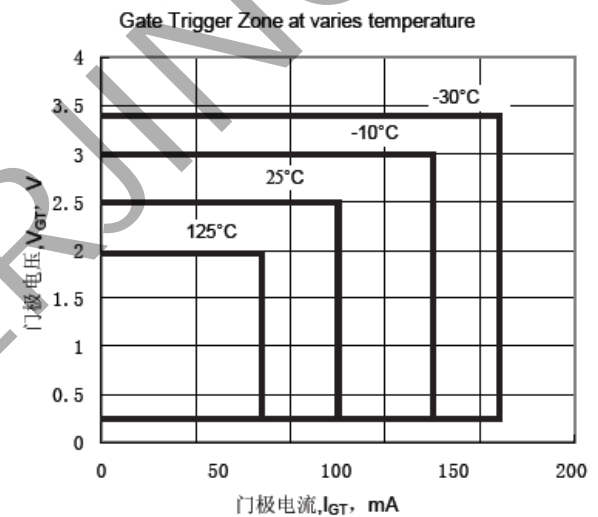

Fig.10 门极触发特性曲线

外形图:



图 1



线路图:

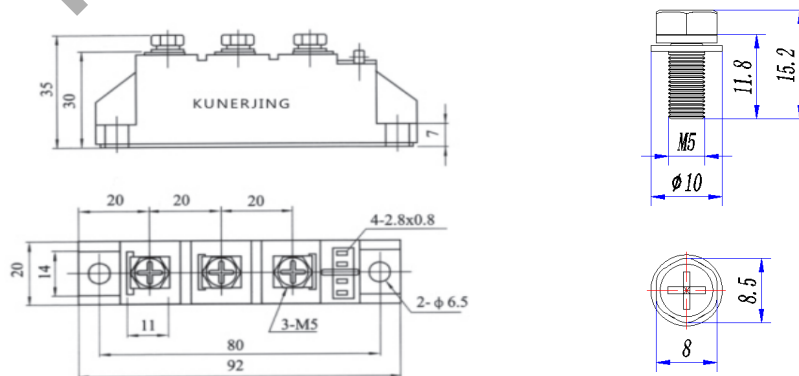
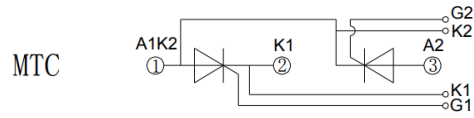

KUNERJING